

# Bandpass Filter 252152B



## 1. Features

- IF bandpass filter
- Low-Loss Filter
- Single-ended operation
- Ceramic Surface Mount Device(SMD) Package
- Maximum Storage Temperature Range : -40 °C ~ 85 °C
- Electrostatics Sensitive Device (ESD)

## 2. Package Dimension

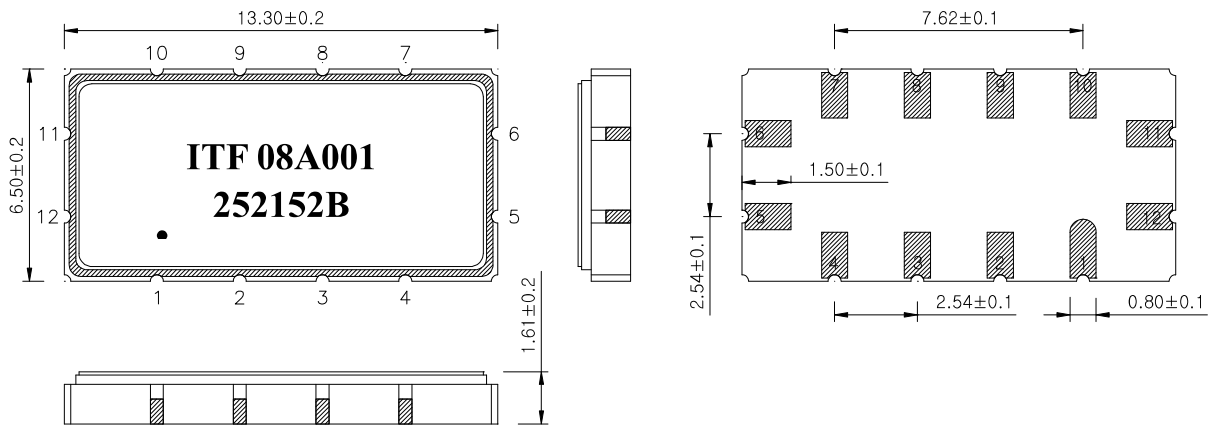

**Package : S1365**

Dimensions shown are nominal in millimeters

Body : Al<sub>2</sub>O<sub>3</sub>

Lid : Kovar, Ni Plated

Termination : Au plating 0.3 ~ 1.0um, over a 1.27 ~ 8.89um Ni Plating

Pin Configuration	
11	Input
5	Output
6, 12	Ground
Other	Case ground

	<b>ITF Co., Ltd.</b> 102-901, Bucheon Technopark 364, Samjeong-Dong, Ojeong-Gu, Bucheon-City, Gyeonggi-Do, Korea 421-809	Part No.	252152B	
		Rev. Date	2008-07-05	
		Rev.	NJ8011-CS01	1/5

# Bandpass Filter 252152B



## 3. Specifications

Fo = 100.0 MHz

Terminating source impedance : 50Ω and matching network

Terminating load impedance : 50Ω and matching network

Room temperature : +25°C		Minimum	Typical	Maximum
Center Frequency (Fc)	MHz	-	100.0	-
Insertion Loss	dB	-	11.5	14.5
1dB Bandwidth	MHz	-	20.47	-
3dB Bandwidth	MHz	21.0	21.35	21.5
40dB Bandwidth	MHz	-	25.35	26.0
Amplitude Ripple (Fo +/- 9.32 MHz)	dB	-	0.4	1.0
Group Delay Variation (Fo +/- 9.32 MHz)	nsec	-	30	60
Absolute Delay	usec	-	0.84	-
Ultimate Rejection	dB	40	45	-
Temperature Coefficient of Frequency (TCF)	ppm/°C	-	- 86	-

### Notes :

- 1) All specifications are based on the matching schematic shown below
- 2) All specifications are measured by Agilent Network analyzer and full 2 port calibration
- 3) Electrical margin has been built into the design to account for the variations due to temperature drift and manufacturing tolerances
- 4) All attenuation measurements are measured relative to insertion loss

 Integrated Technology Future	<b>ITF Co., Ltd.</b> 102-901, Bucheon Technopark 364, Samjeong-Dong, Ojeong-Gu, Bucheon-City, Gyeonggi-Do, Korea 421-809	Part No.	252152B	
		Rev. Date	2008-07-05	
		Rev.	NJ8011-CS01	2/5

# Bandpass Filter 252152B



## 4. Matching Schematic

( Actual matching values may vary due to PCB layout and parasitics )

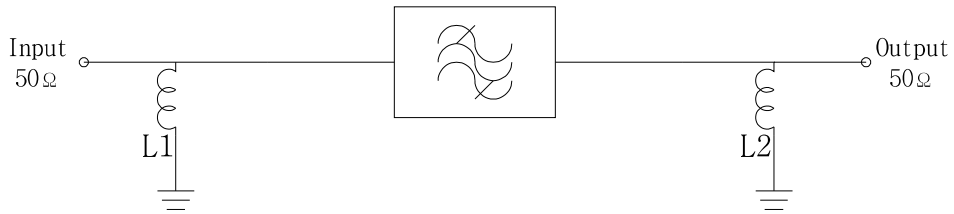

$$L1 = 82 \text{ nH}, \quad L2 = 68 \text{ nH}$$

## 5. Marking Configuration

ITF<sup>1)</sup> 08A001<sup>2)</sup>

252152B<sup>3)</sup>

●<sup>4)</sup>

1) Manufacturer name

2) Lot Number

3) Part Number

4) Pad Number 1 Index

	<b>ITF Co., Ltd.</b> 102-901, Bucheon Technopark 364, Samjeong-Dong, Ojeong-Gu, Bucheon-City, Gyeonggi-Do, Korea 421-809	Part No.	252152B	
		Rev. Date	2008-07-05	
		Rev.	NJ8011-CS01	3/5

# Bandpass Filter 252152B



## 6. Typical Performance ( at +25°C )

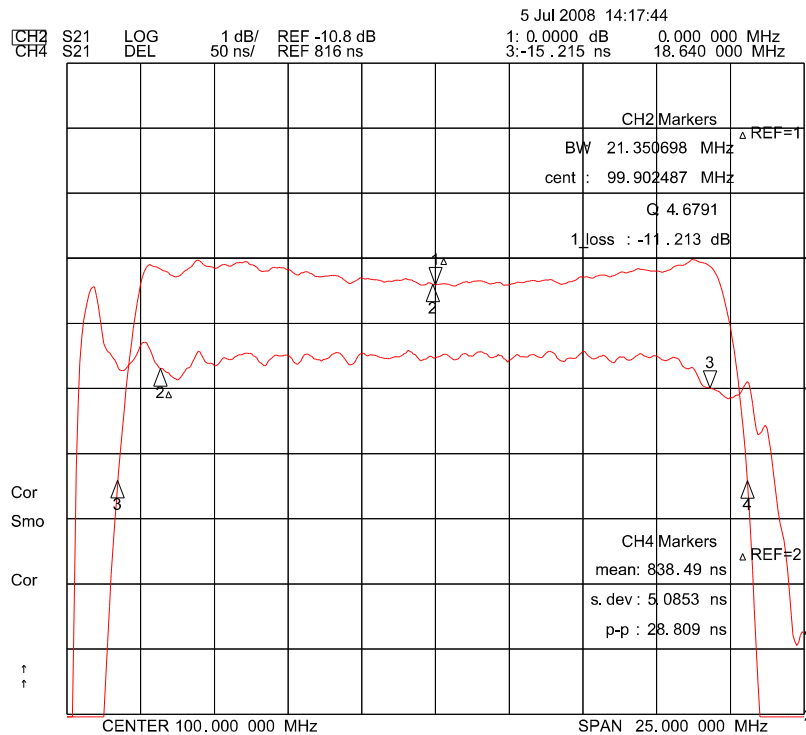
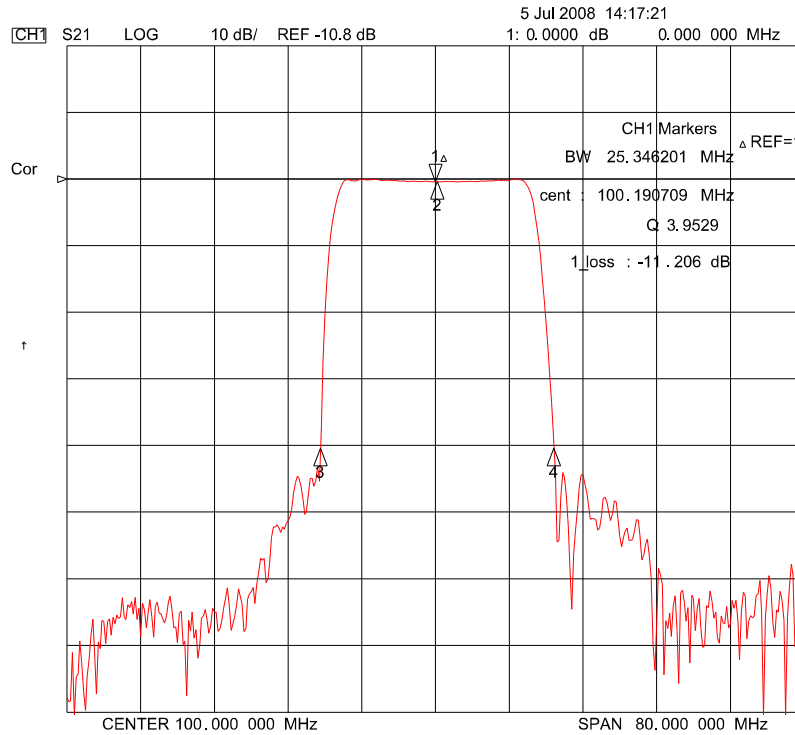

**ITF Co., Ltd.**  
 102-901, Bucheon Technopark 364,  
 Samjeong-Dong, Ojeong-Gu, Bucheon-City,  
 Gyeonggi-Do, Korea 421-809

Part No.	252152B	
Rev. Date	2008-07-05	
Rev.	NJ8011-CS01	4/5

# Bandpass Filter 252152B

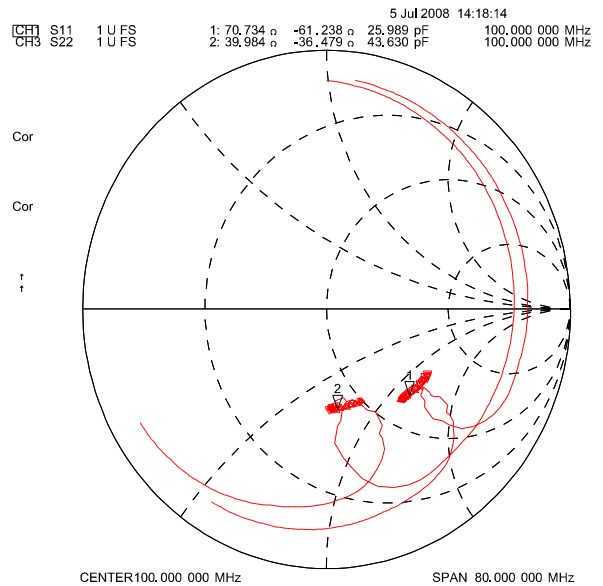
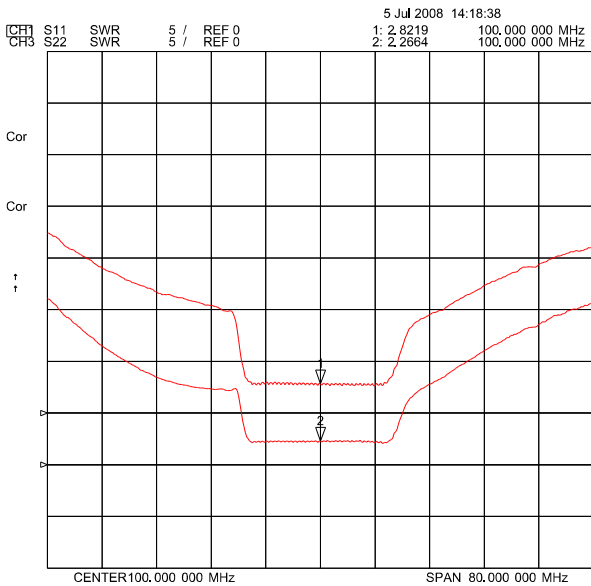
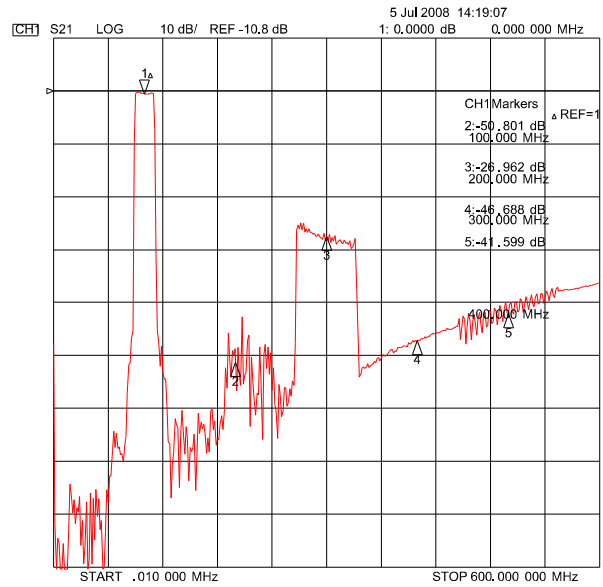
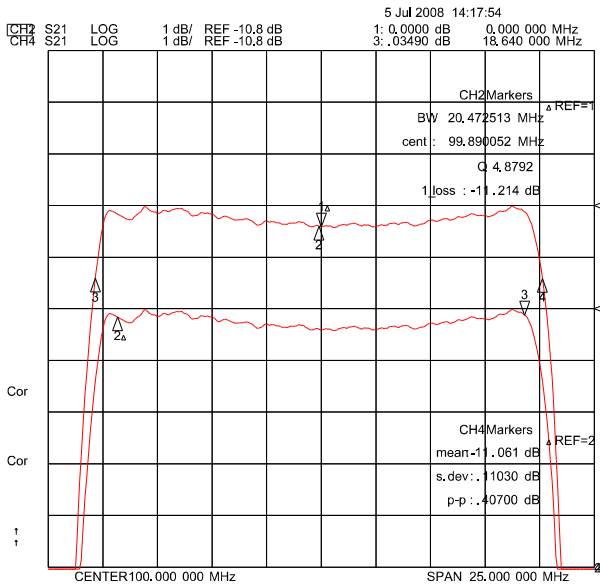

**ITF Co., Ltd.**  
 102-901, Bucheon Technopark 364,  
 Samjeong-Dong, Ojeong-Gu, Bucheon-City,  
 Gyeonggi-Do, Korea 421-809

Part No.	252152B	
Rev. Date	2008-07-05	
Rev.	NJ8011-CS01	5/5